







SANDVIK PLAY

INULA 2

14-ELDAN023RC6AL



			
86.5m ²	2,00m	3-14	22

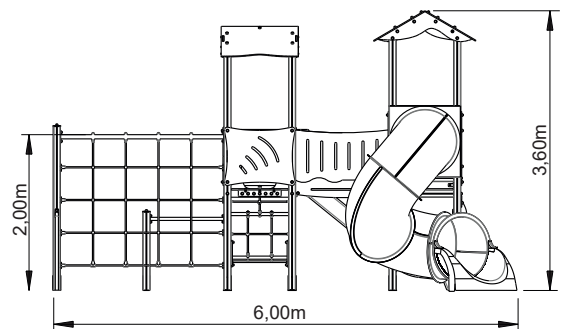
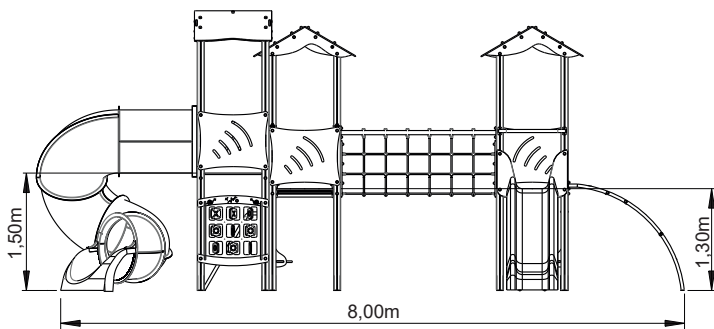

Utilização do equipamento sujeito a condições vigiadas; Zona de segurança: Área mínima requerida pela norma EN 1176-1,6
Utilización del equipo sujeto a condiciones vigiladas; Zona de seguridad: Área mínima requerida por la norma EN 1176-1,6
Use of equipment subject to supervised conditions; Safety zone: Minimum area required by EN 1176-1,6
Utilisation d'équipement soumis à des conditions supervisées; Zone de sécurité: Surface minimale requise par l'EN 1176-1,6



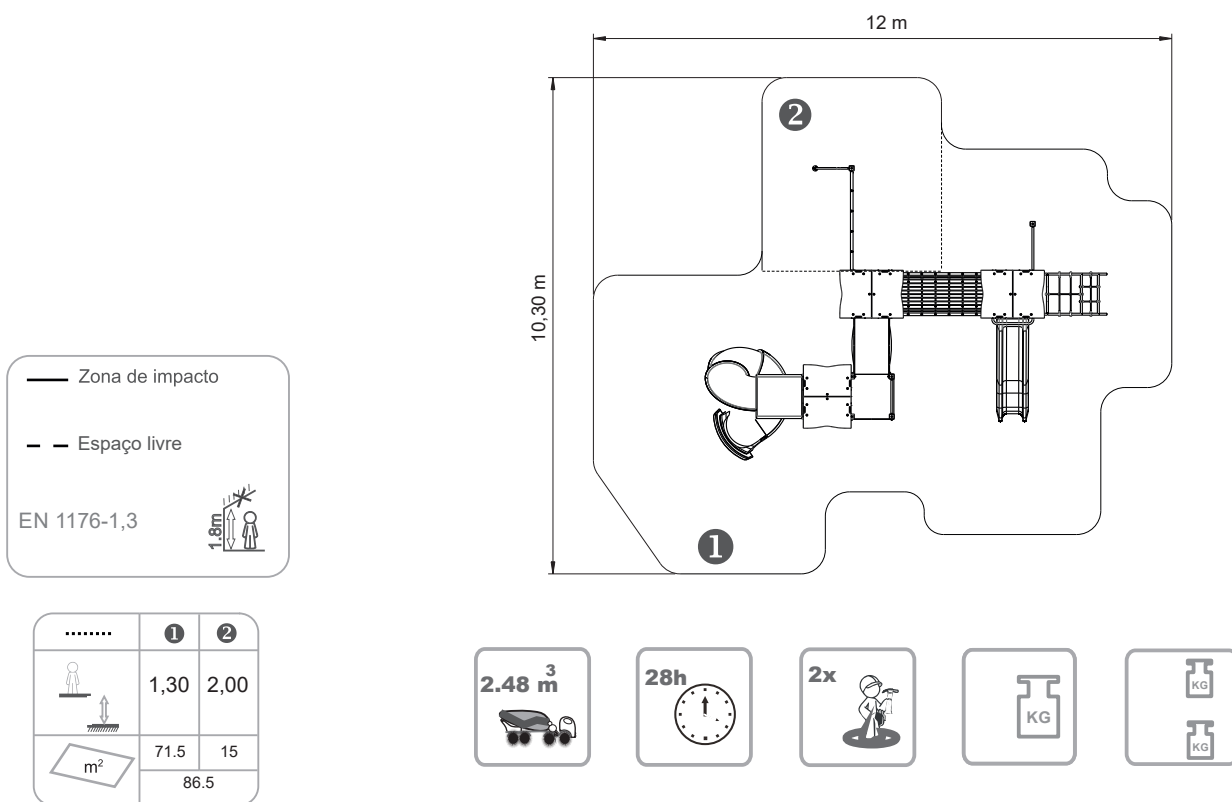

INFORMAÇÃO TÉCNICA / INFORMACIÓN TÉCNICA / TECHNICAL INFORMATION / INFORMATIONS TECHNIQUES

- 1 - Torre Nuvem 1.30m
- 2 - Torre Nuvem 1.50m
- 3 - Torre Simples 1.30m
- 4 - Escorrega 1.30m
- 5 - Escorrega 1.50m
- 6 - Ponte de Cordas 1.30m
- 7 - Rede de Escalada 2.00m
- 8 - Ponte 1.30m
- 9 - Escalada 1.30m
- 10 - Barra 0.93m
- 11 - Banco 0.40m
- 12 - Escada 1.30m
- 13- Jogo do Galo

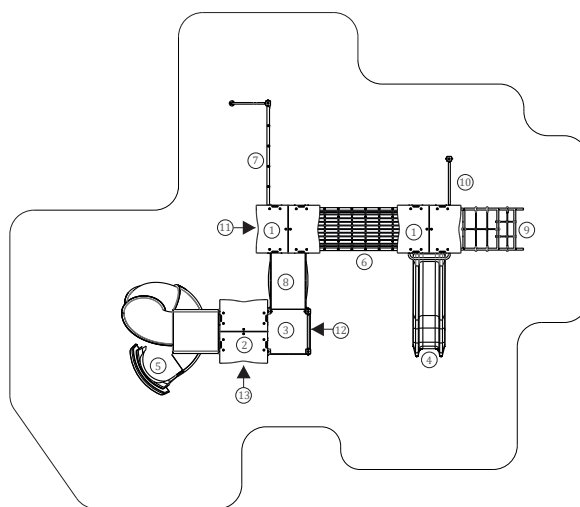



Plums

Aluminum: Profile of 90x90x2.5mm in alloy 6063 and T66 treatment, this is an extrusion alloy par excellence, presents an excellent resistance to corrosion, with a good surface finish. The T66 treatment in which this alloy is solubilized, tempered and artificially aged, aims to improve its mechanical properties. This is supplied to the natural color with the option of being lacquered to the RAL that the customer wants;

Panels

HDPE: High density polyethylene mono or two color. Being a polymer is characterized by its resistance to chemicals and corrosion. Due to its elasticity and lightness, it offers high impact resistance and is very difficult to break. The non-slip surface provides safety for children and its synthetic base prevents the growth of bacteria and fungi. It does not require any maintenance;

Net

ropes Ø16mm reinforced in steel covered by polypropylene fibers, fittings and connection in HDPE plastic with U.V. protection, fastening elements in hot galvanized steel;

Marine Plywood

anti-slip, bonded with weather resistant phenol resins and UV rays. in accordance with standards EL 314-2 / class 3 (DIN 68 TS TCIL3: BFU 100, BS 6566 PART 8: WBP);

Plastic parts

Slide: high density polyethylene, resistant to UV rays, high breaking strength and maximum safety;

Metal parts

Pipes: Stainless steel AISI 304 of Ø40mm and Ø54mm;

Fixation System

Type B – Standard fastening system consisting of metal base bolted to the ground with metal bushings;

Type C – Standard fixing system composed of plumbing applied directly to the ground and cast with concrete;

Screws and accessories

Screws: Zinc-plated steel or optionally AISI 304 stainless steel;

Capsules: PP polypropylene plastic;

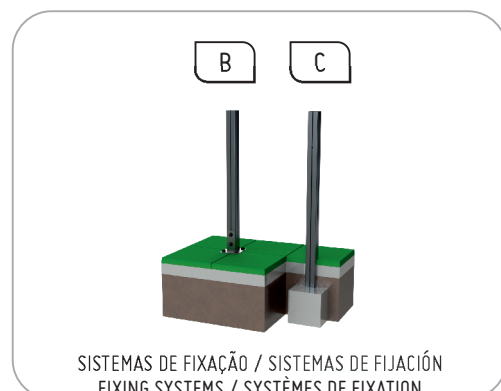



Fun: While having fun, children acquire immense abilities, from physical abilities to social interactions.



Socializing: Socialization and imagination are necessary throughout the game. All this creates a relationship between children and awakens the sense of coexistence and solidarity.



Play: Develops patience, sharing and sporting spirit.



Climb: It develops children's motor skills, body control, balance and coordination, stimulating motor ability and strength in movements.



Sliding: The sloping surface allows the child to slide at high speed. The sensation of speed makes you feel alive and learn to control your movements by exercising reflexes and motor skills.