

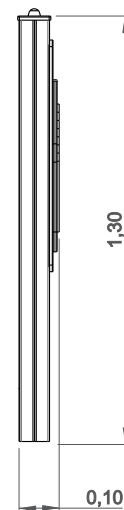

SANDVIK PLAY

PACMAN (METALL)

14-ELDAN066AL

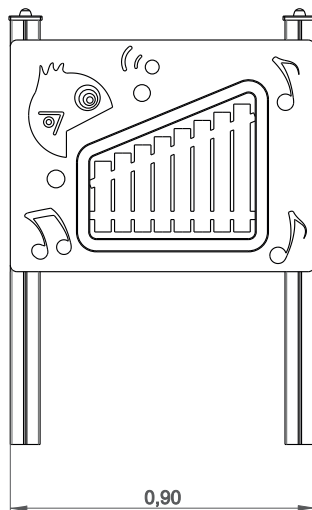
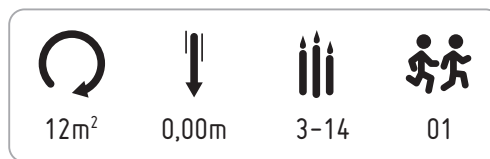

Utilização do equipamento sujeito a condições vigiadas; Zona de segurança: Área mínima requerida pela norma EN 1176-1,6
Utilización del equipo sujeto a condiciones vigiladas; Zona de seguridad: Área mínima requerida por la norma EN 1176-1,6
Use of equipment subject to supervised conditions; Safety zone: Minimum area required by EN 1176-1,6
Utilisation d'équipement soumis à des conditions supervisées; Zone de sécurité: Surface minimale requise par l'EN 1176-1,6



— Zona de impacto
 - - Espaço livre

EN 1176-1,3

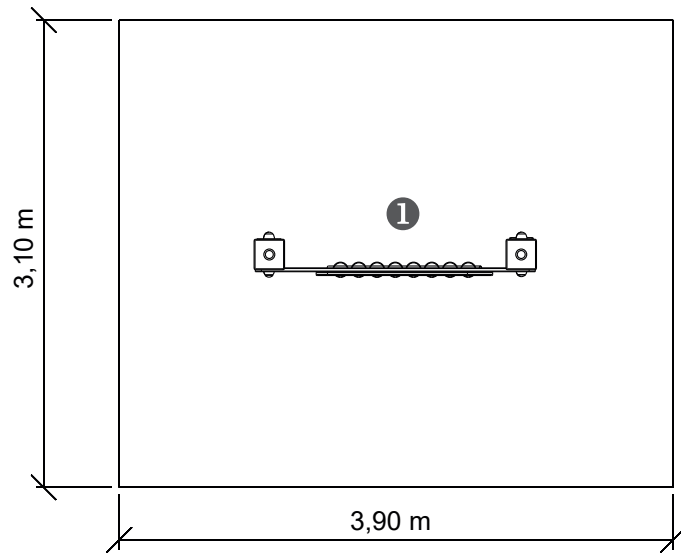

.....	1
	0,00
	12
	12

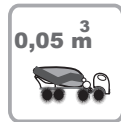

INFORMAÇÃO TÉCNICA / INFORMACIÓN TÉCNICA / TECHNICAL INFORMATION / INFORMATIONS TECHNIQUES

1 - Placa Pacman Música

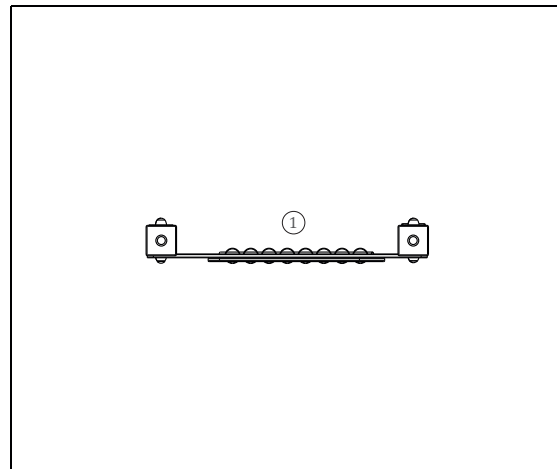



Plums

Aluminum: Profile of 90x90x2.5mm in alloy 6063 and T66 treatment, this is an extrusion alloy par excellence, presents an excellent resistance to corrosion, with a good surface finish. The T66 treatment in which this alloy is solubilized, tempered and artificially aged, aims to improve its mechanical properties. This is supplied to the natural color with the option of being lacquered to the RAL that the customer wants;

Panels

HDPE: High density polyethylene mono or two color. Being a polymer is characterized by its resistance to chemicals and corrosion. Due to its elasticity and lightness, it offers high impact resistance and is very difficult to break. The non-slip surface provides safety for children and its synthetic base prevents the growth of bacteria and fungi. It does not require any maintenance;

Metal Pieces

Fixation system: allows its placement on the ground without the wood coming into direct contact with the earth. The bottom of these fastening systems are anchored to the ground. Manufactured in galvanized sheet steel;

Type A – Standard fixing system composed of metal base embedded in the ground and cast with concrete;

Type B – Standard fastening system consisting of metal base bolted to the ground with metal bushings;

Type C – Standard fixing system composed of plumbing applied directly to the ground and cast with concrete;

Screws and accessories

Screws: Zinc-plated steel or optionally AISI 304 stainless steel;

Capsules: PP polypropylene plastic;

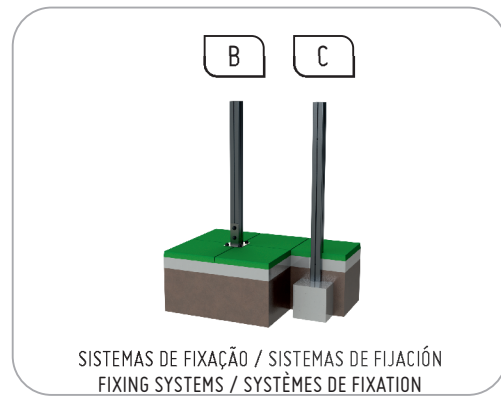

FUNÇÕES LÚDICAS/ FUNCIONES LÚDICAS / RECREATIONAL FUNCTIONS / FONCTIONS RÉCRÉATIVES



Fun

While having fun, children acquire immense abilities, from physical abilities to social interactions.



Socializing

Socialization and imagination are necessary throughout the game. All this creates a relationship between children and awakens the sense of coexistence and solidarity.



Play

Develops patience, sharing and sporting spirit.