

Adventure Play







PSTE000.225

Hill slide



PSTE000.225

Hill slide

-  1+
-  2 - 6
-  2.3 x 0.9 x 1.2 m
-  1.5 x 2.6 m
-  5.3 x 3.6 m
-  < 0.6 m

Playfunctions

Sliding, climbing

Material

Made of irregularly shaped Acacia Robinia FSC certified wood. This European hardwood had a sustainability of class I according to EN 350 and is free of sapwood. The timber units are finished with stainless steel components 340 / K320-ground quality. Matching slides are stainless steel 304 quality polished stainless steel and all fastenings are A2 quality.

Anchorage

Galvanized steel base plates

Comments

The impact area must have impact absorbing properties belonging to the specified free height of fall. The obstacle-free zone shall be completely free of obstacles.

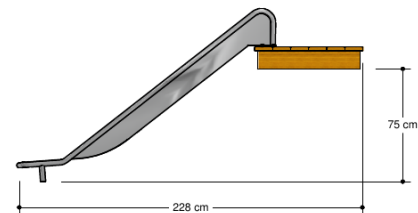
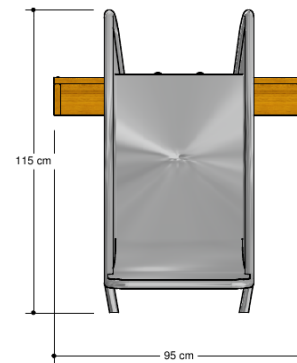
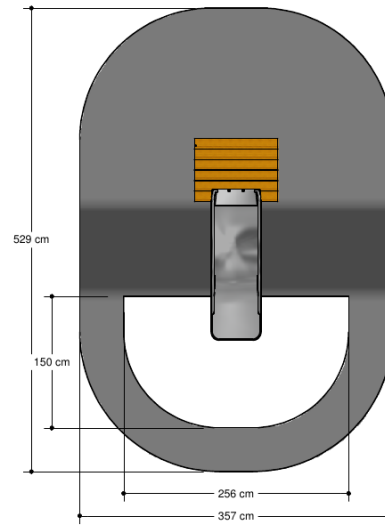

Opvangzone Impact area

 WAS, Dutch law

 EN1176

Obstakelvrije zone Obstacle free zone

 WAS, Dutch law

 EN1176

