

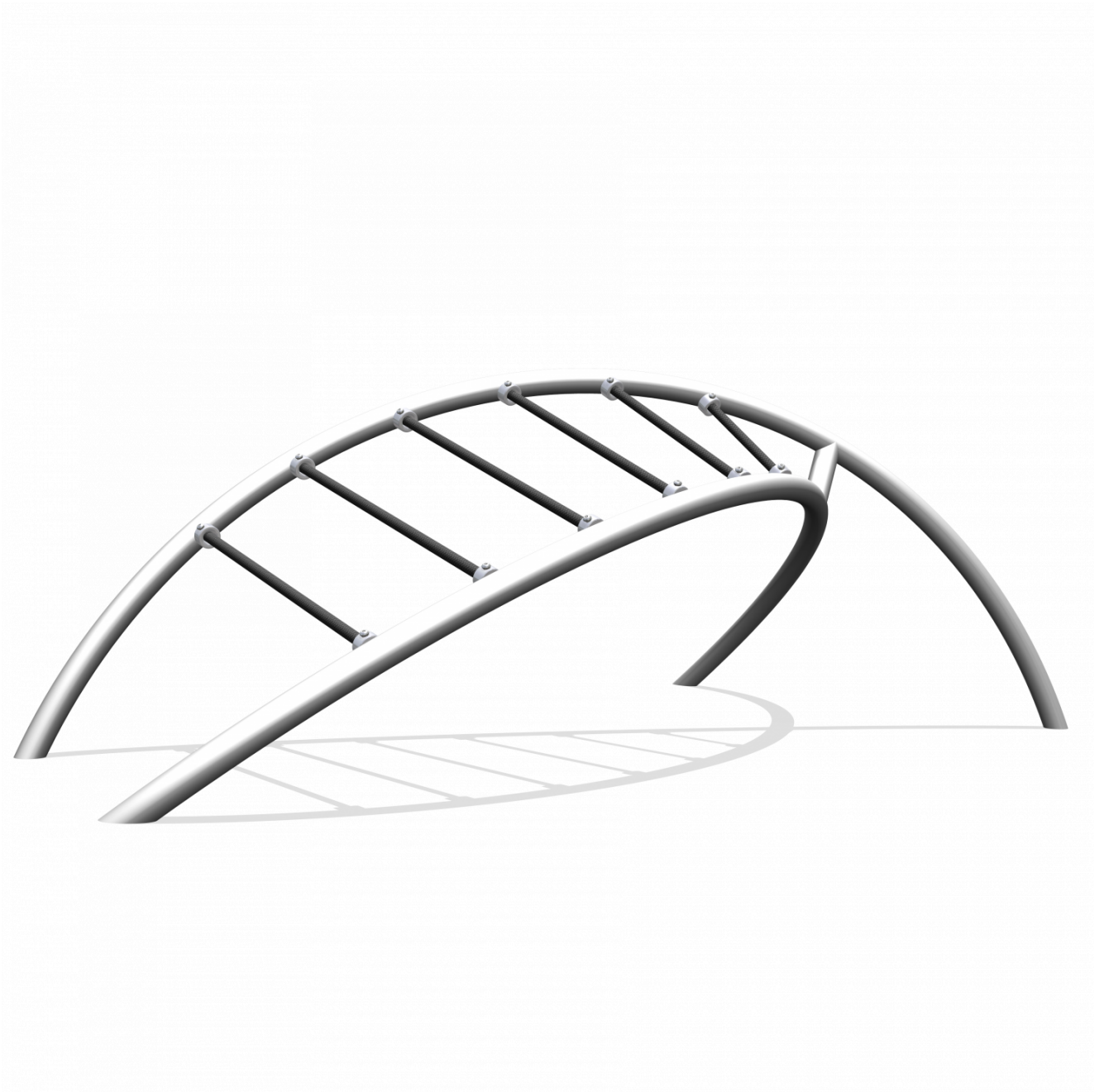

Little-Play Twisted

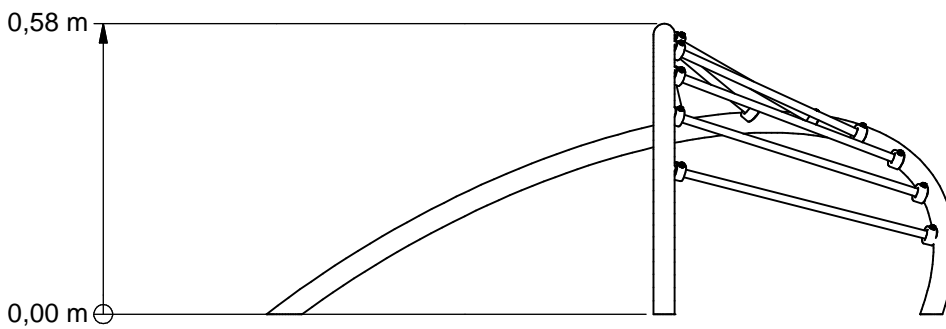

LTPE381.706

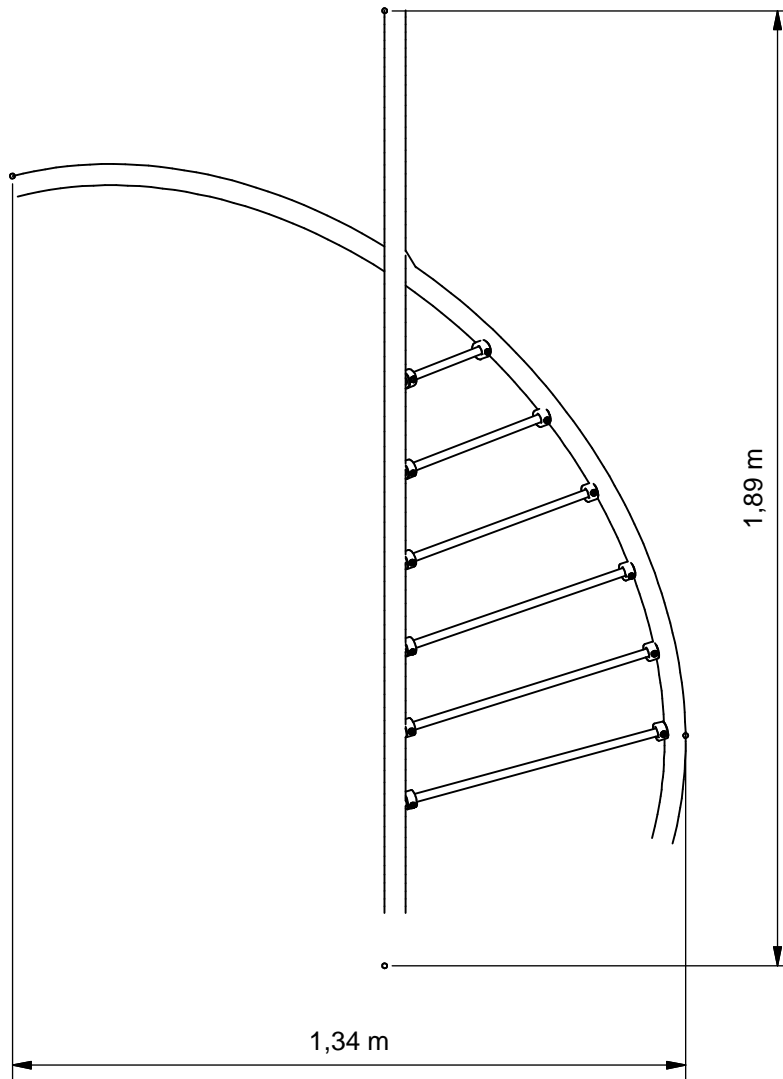

Benaming
Title Twisted

Opmerking
Comment Little Play

Datum
Date 28-2-2014

Tekening
Drawing

TOE LTP 381 706

Afmetingen Dimensions

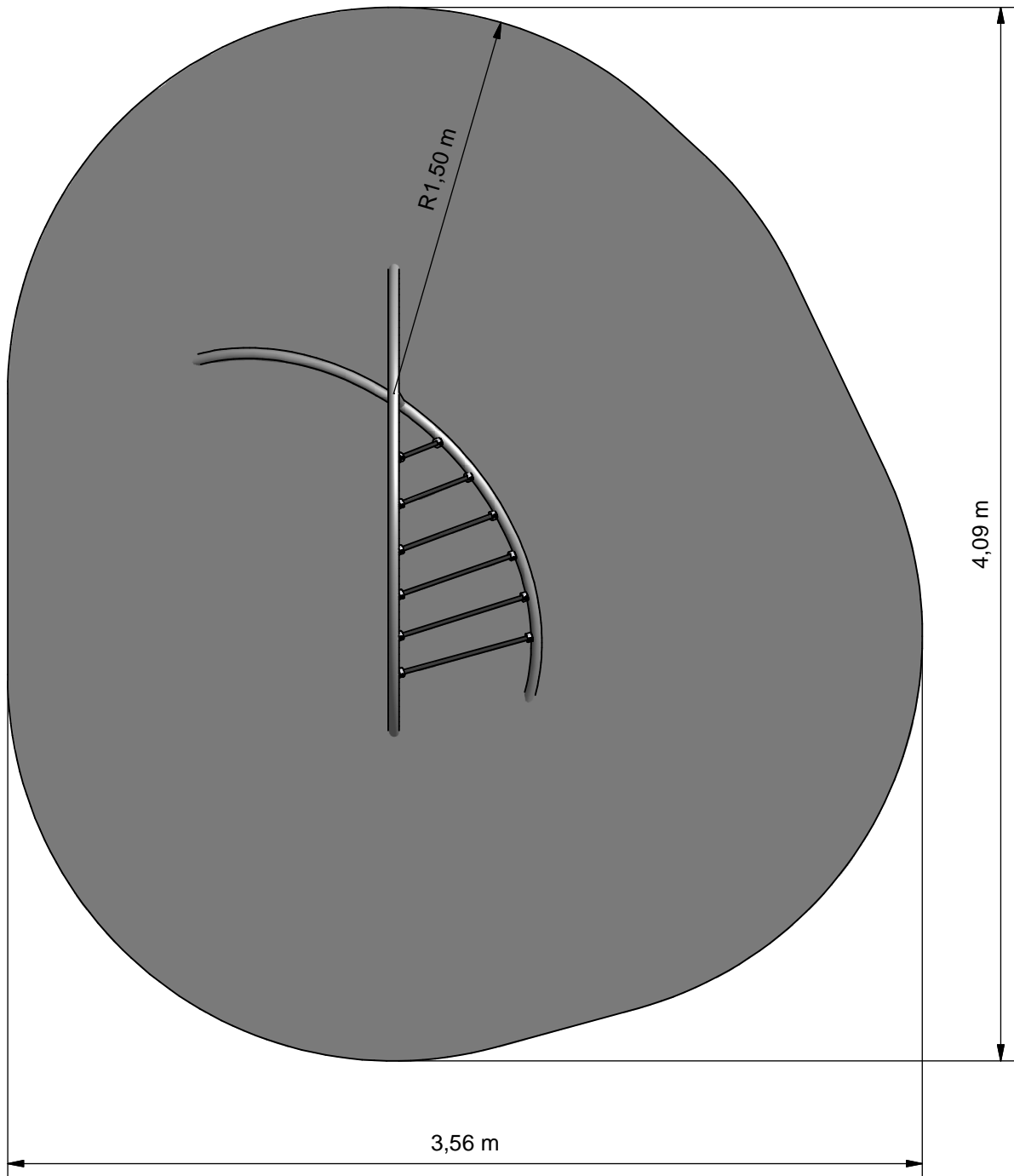

- Opvangzone
Impact area
- Obstakelvrije zone
Obstacle free zone



Benaming
Title Twisted

Opmerking
Comment Little Play

Datum
Date 28-2-2014

Tekening
Drawing

TOE LTP 381 706

Obstakelvrije zone *Obstacle free zone*

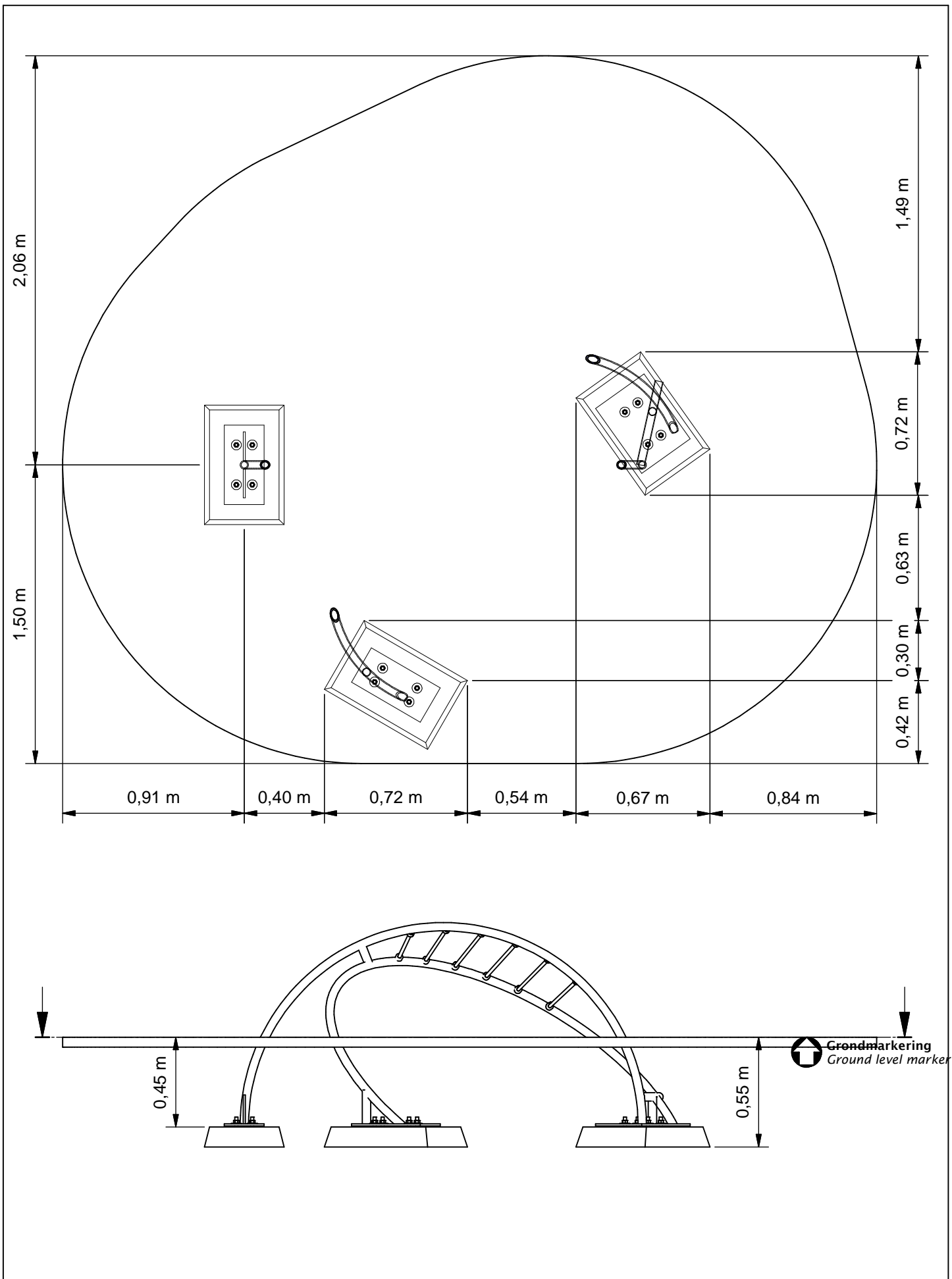

Benaming / Title: Twisted
 Opmerking / Comment: Little Play
 Datum / Date: 28-2-2014

Tekening / Drawing

TOE LTP 381 706

Bodemplan Groundplan

Geleverde modules:

Zie tabel

Supplied modules:

See table

Montageinstructie:

- De hoofdmaten geven de maten van de standers en vloeren aan
- De detailtekeningen geven specifiek de maten van de verbindingen aan
- De modules met buizen zijn op de tekeningen bemaat op bovenkant kopplaat
- Overige modules zijn bemaat op de bovenkant (klimwanden, paalkoppen, etc.)

Assembly instruction:

- The main dimensions indicate the dimensions of the posts and floors
- The detailed dimensions show the specific dimensions of the connections
- The modules which contain tubes are dimensioned at the top of the flanges
- Other modules are dimensioned at the top (climbing walls, caps for the posts, etc.)

Montagevolgorde:

- 1 - Graaf de gaten volgens het bodemplan
- 2 - Plaats 2(3x)
- 3 - Plaats 1, verbind deze aan drie keer 2
- 4 - Controleer of het toestel voldoet aan de afmetingen zoals op blad 'afmetingen'
- 5 - Dicht de gaten en verdicht het zand

Assembly sequence:

- 1 - Dig the holes according to the ground plan
- 2 - Place 2(3x)
- 3 - Place 1, attach it to tree times 2
- 4 - Check that the equipment conforms to the dimensions shown on sheet 'dimensions'
- 5 - Close the holes and compact the sand

Controles:

- 1 - Correcte opbouw en alle bevestigingsmiddelen
- 2 - Controleer de afmetingen van de valbodem t.o.v. het toestel

Checks:

- 1 - Correct assembly and all the fasteners
- 2 - Check the dimensions of the safety area with regard to the play equipment

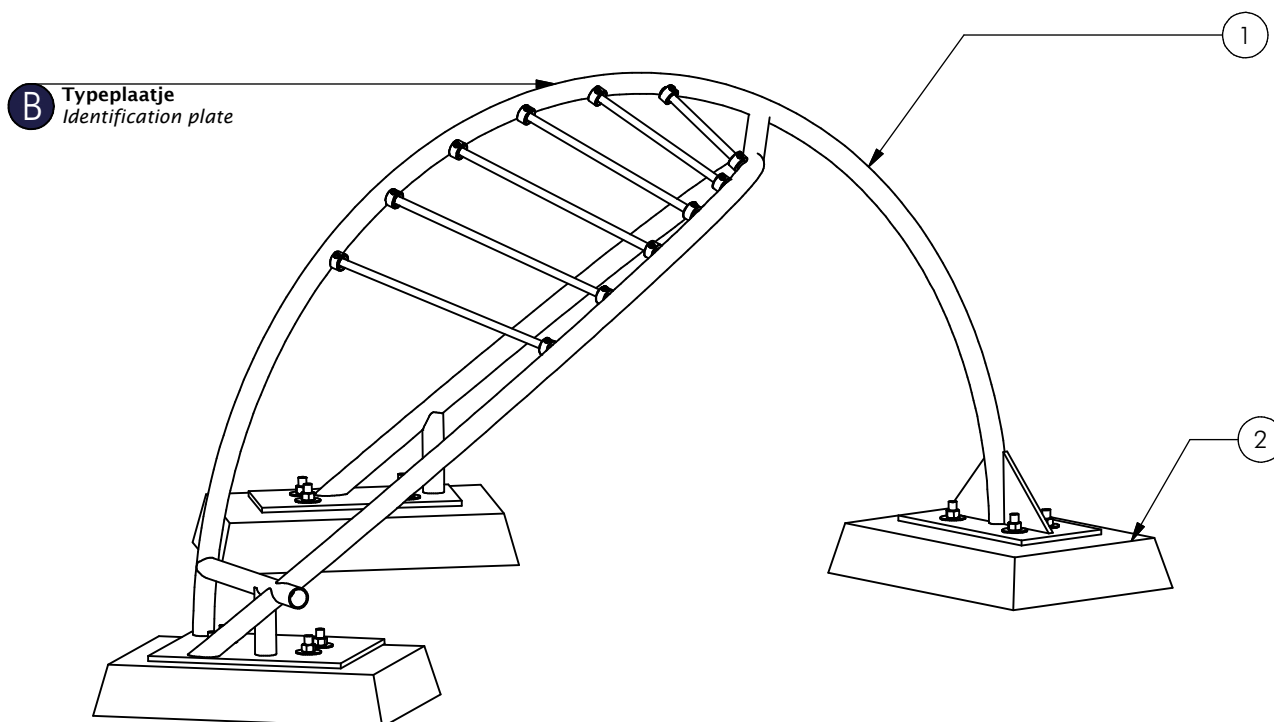

Nr	#	Type	Progr.	Volgnr	Bew.	Rev.	Benaming	Opmerking
1	1	MOD	LTP	706	001		Twisted	Little Play
2	3	MOD	OBT	010	001		Poermodel 10	50 kilo



Benaming
Title Twisted

Opmerking
Comment Little Play

Datum
Date 28-2-2014

Tekening
Drawing

TOE LTP 381 706

Modules Modules

LTPE381.706

Little-Play Twisted

LOGBOOK

(Onderstaand logboek kan gebruikt worden om te voldoen aan de eisen, gesteld in artikel 14 van het Warenwetbesluit Attractie- en Speeltoestellen)

Type indication	Play triggers
Product code	LTPE381.706
Name of equipment	Little-Play Twisted
Maximum height of fall	< 0,6 m
Year of construction	2017
Certificate	0183402366
inspection authority	NVT -
Name manufacturer	BOERplay Hyacintstraat 2 - 4255 HX Nieuwendijk Phone: +31 (0)183 40 23 66 Fax: +31 (0)183 40 35 64
name installer	_____ _____
Description of equipment	Little-Play Twisted
Location of equipment	_____
Data about the owner of the play equipment	
Name:	_____
Address:	_____
Postcode and town:	_____
Contact person:	_____
Telephone number:	_____
Data about the administrator of the play equipment	
Name:	_____
Address:	_____
Postcode and town:	_____
Contact person:	_____
Telephone number:	_____

LOGBOOK

Inspection and maintenance intervals



Nr.	Inspection	Maintenance	months between inspections
1	Verify equipment's stability, junctions and missing parts. Inspect bolts, screws and nuts for absence, jams, corrosion and wear.	Add missing parts, secure joints, apply missing fixing agent and replace corroded parts.	1
2	Check suspension for wear.	Replace worn parts and/or remove non-functioning parts.	1
3	Inspect rotating parts such as hinges, rolling-element bearings, etc. for wear and acceptability.	Replace worn parts and/or remove non-functioning parts.	1
4	Check wood for splinters, unacceptable damage and signs of rot. Especially at ground level.	Repair damage. Replace affected wood. Smoothen splintered wood and sharp edges.	1
5	Inspect foundation for stability, tearing and coverage.	Restore foundation and covering material.	3
6	Examine rubber and synthetic parts for wear, damage and break.	Replace original parts.	3
7	Inspect metal for corrosion and damage in the coating.	Restore any damaged coating (after removing rust and applying primer).	6
8	Check ropes, cables, chains and nets for wear and damage. Steel cables and nets which are tensioned must be checked for tension.	Replace parts where necessary. Steel cables and nets must be tensioned.	3
9	Inspect equipment for unsafe changes and additions.	Remove unsafe additions and correct unsafe changes.	1
10	Inspect safety surfaces.	Restore and repair where necessary.	1

Remarks

1. If used intensively, all points require extra attention.
2. Extreme weather conditions and locations may require a higher inspection frequency. Discuss this with the supplier.
3. Vandalism-sensitive locations require stricter inspections, possibly daily.
4. Check the terrain regularly for items that do not belong there, are unsafe or may be used wrongly. Examples are poisonous plants, glass shards, etc. Frequency depends on strain.
5. Remember that bad maintenance leads to unsafe conditions and notably faster impoverishment of the playground area.
6. Replacement parts can be ordered at the manufacturer with the part numbers on the module drawing. Drawings can be found in de user guide.
7. The impact area shall be provided with impact attenuating surface according to the specified falling height.
8. This list is conform the CEN-standard "playground equipment and surfacing NEN-EN 1176-7".



Dit toestel is geen speeltoestel conform het warenwetbesluit attractie- en speeltoestellen, en is dus niet als zodanig gecertificeerd.

This equipment is not playground equipment, so it has not been certified as such.



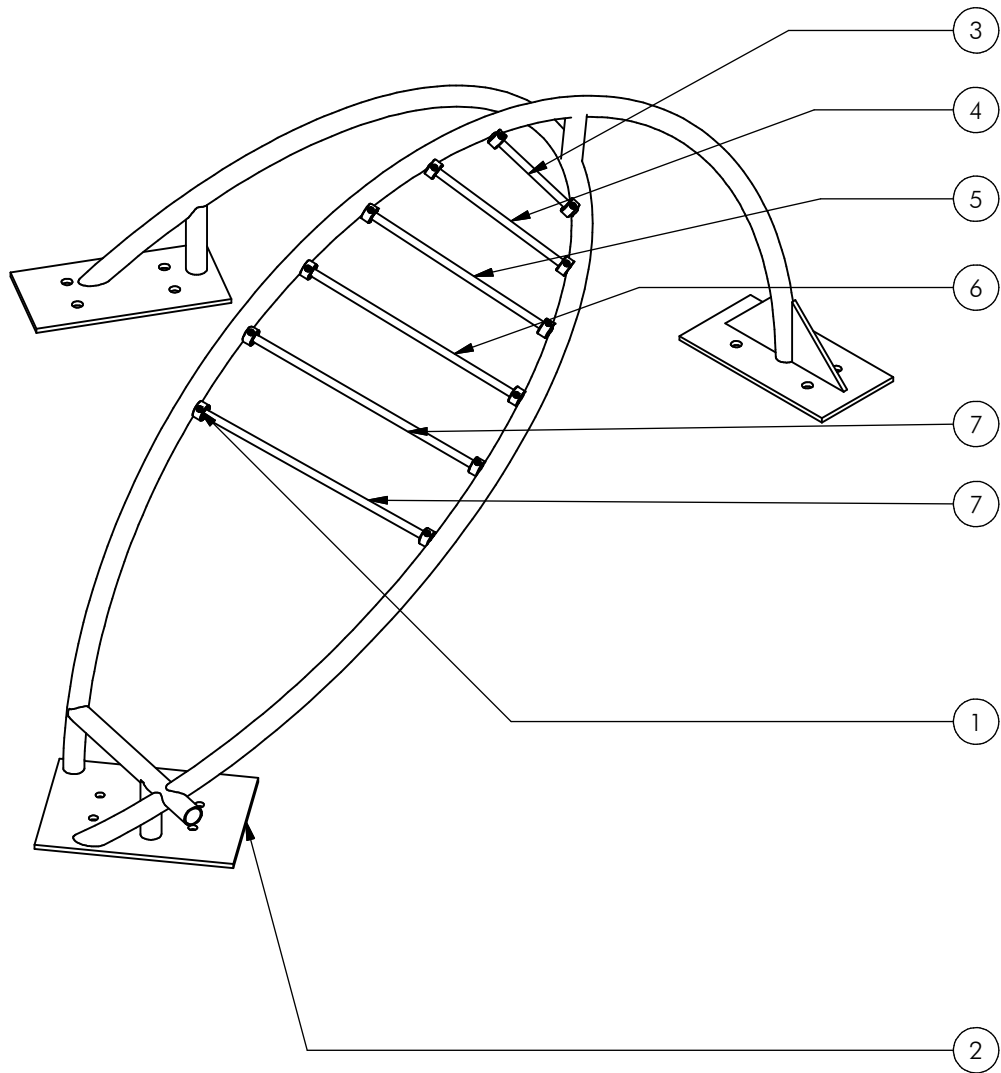

Nr	#	Type	Progr.	Volgnr	Bew.	Rev.	Benaming	Opmerking
1	12	BSV	025	006	030		Veiligheidsschroef	Pin-Torx - VZ 8.8
2	1	SME	LTP	004	906		Laswerk	Twisted
3	1	SNT	LTP	017	090		Touw Ø16	L=270 mm
4	1	SNT	LTP	018	090		Touw Ø16	L= 600 mm
5	1	SNT	LTP	019	090		Touw Ø16	L=390 mm
6	1	SNT	LTP	020	090		Touw Ø16	L=480 mm
7	2	SNT	LTP	022	090		Touw Ø16	L=590 mm



Benaming
Title Twisted

Opmerking
Comment Little Play

Datum
Date 25-1-2017

Tekening
Drawing

MOD LTP 706 001

Samenstelling module Assembly module

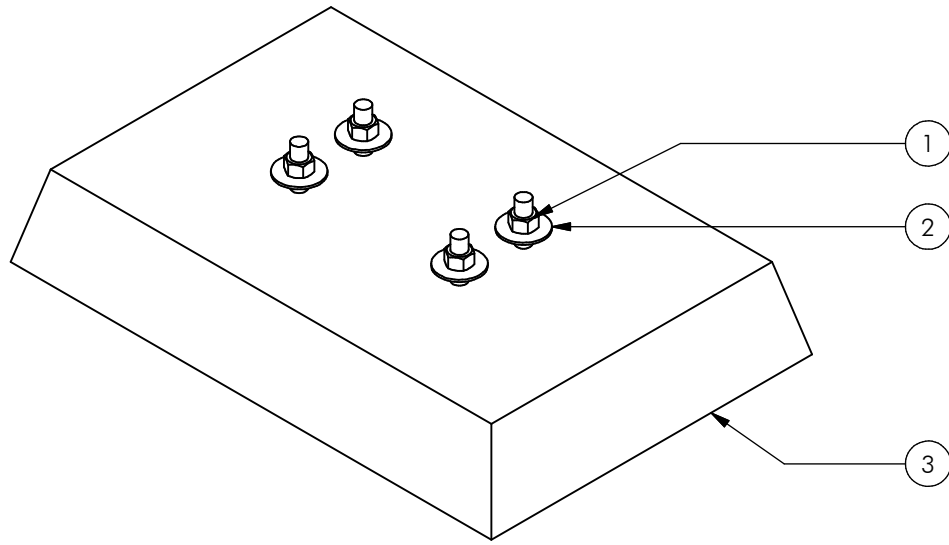

Nr	#	Type	Progr.	Volgnr	Bew.	Rev.	Benaming	Opmerking
1	4	BSV	017	016	015		Zeskantmoer	M16 - VZ 8.8
2	4	BSV	035	016	050		Carrosseriering	M16 x 50 - VZ 8.8
3	1	OBT	POE	010	050		Poermodel 10	50 kg



Benaming
Title Poermodel 10

Opmerking
Comment 50 kilo

Datum
Date 27-8-2015

Tekening
Drawing

MOD OBT 010 001

Samenstelling module *Assembly module*